

System Upgrades That Impact Sustainable Energy Efficiency and Cost Savings

Understanding Efficient vs. Effective

Darren Cooper
Renteknik Group

Andre Patenaude
Emerson Climate Technologies

Overview

- Background
 - Concepts and terminology
 - Data collection
- Location Selection
- Project #1
 - Recommissioning
- Project #2
 - Adiabatic cooling
- Project #3
 - Variable capacity compressors
- Sustaining Savings

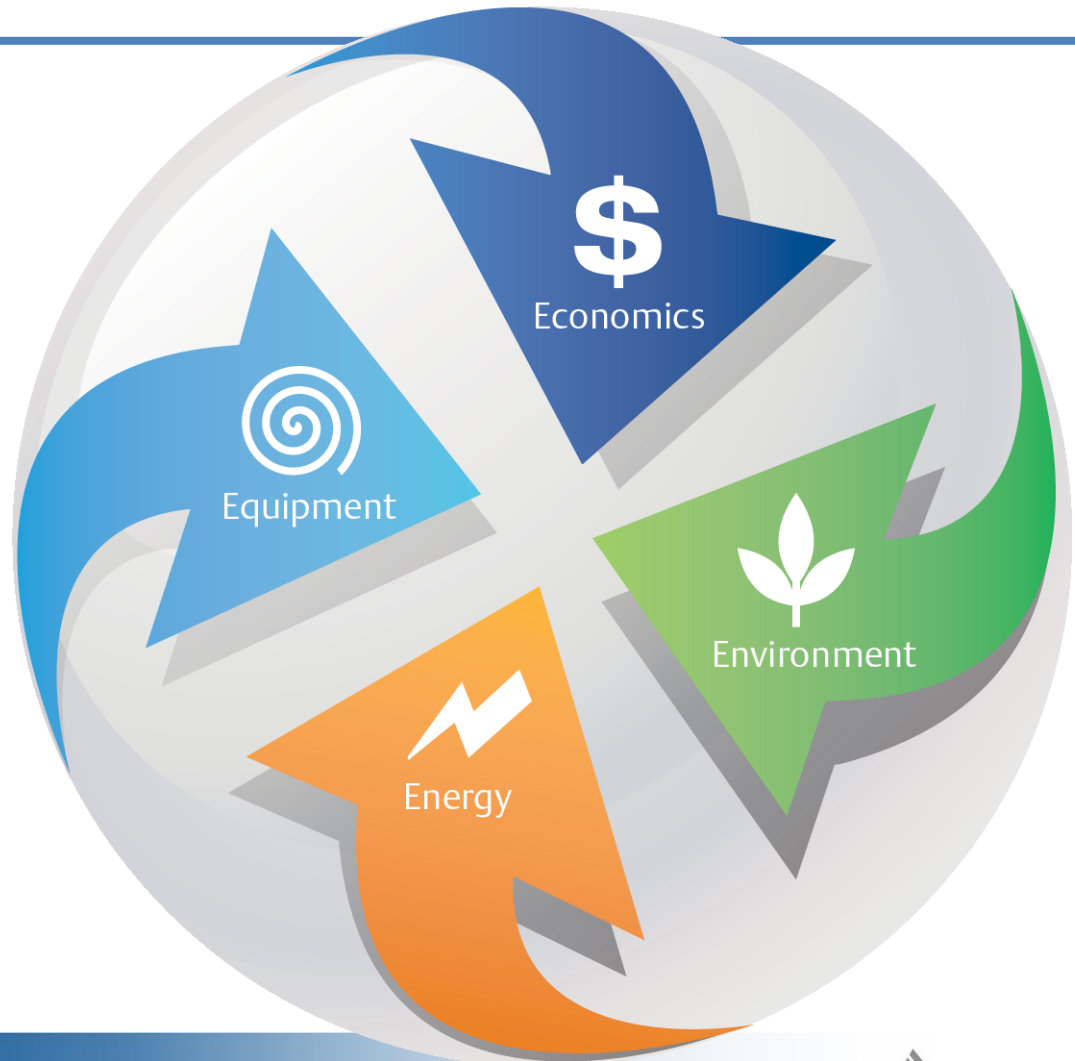

Cost Saving vs. Cost Avoidance

- **Cost Saving: Reduce \$/ft²**

- Not possible if rates (\$/kWh) are rising faster than ability to reduce energy intensity (kWh/ft²)
- Cost savings (\$) = $(\$/\text{ft}^2_{\text{Old}} - \$/\text{ft}^2_{\text{New}}) * (\text{ft}^2_{\text{New}})$

- **Cost Avoidance: Reduce kWh/ft²**

- A truer measure of achievement
- How we track progress for sustainability reporting
- Cost avoidance (\$) = $(\text{kWh}/\text{ft}^2_{\text{Old}} - \text{kWh}/\text{ft}^2_{\text{New}}) * (\$/\text{kWh}_{\text{New}}) * (\text{ft}^2_{\text{New}})$

Energy Conservation Efforts

■ Incentives (\$/kWh)

- Typically reduce Simple Payback by one year
- One-time benefit, which can increase or decrease
- Vary by state/province

■ Rates (\$/kWh)

- Ongoing cost, which typically only increases
- Vary by state/province

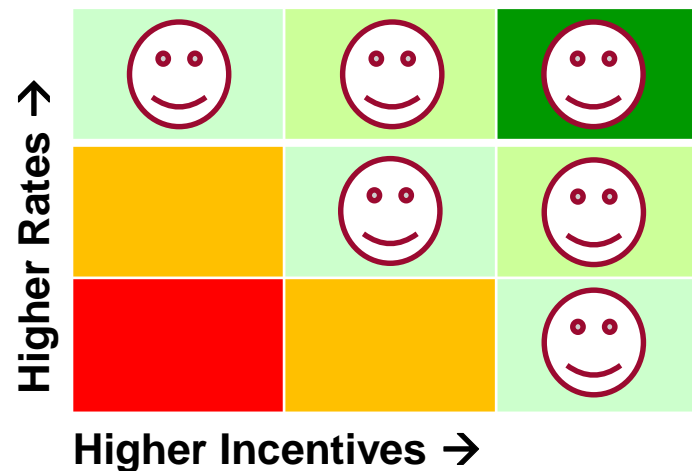

Typical Full-Service Format Store

- **~50,000 ft²**
- **Electricity**
 - ~\$35/hour x 8,760 hours/year = ~\$300,000/year
 - Refrigeration represents ~60% = ~\$180,000/year
- **Centralized refrigeration racks**
 - Medium-temperature: 5 to 7 compressors
 - Low-temperature: 5 to 7 compressors



Efficiency and Effectiveness

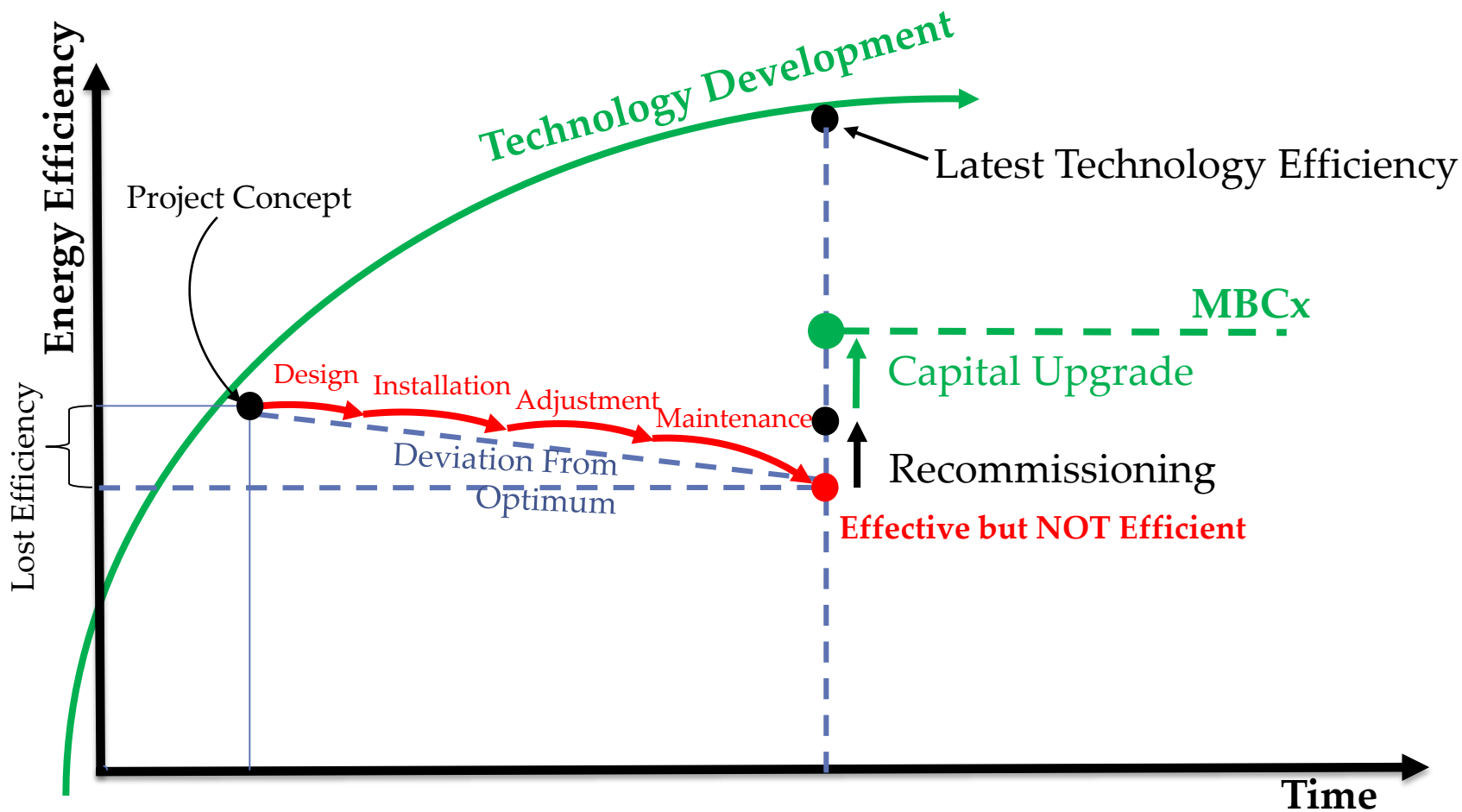

Understanding Terminology

■ Commissioning

- Commissioning is a “**quality-oriented process**” designed to ensure that a building, facility or system is **designed, constructed and operated** to meet the Owner’s Project Requirements (OPR).

■ Recommissioning

- The commissioning of an existing building, facility or system that was previously commissioned. Review the original commissioning documentation and identify changes. Update original document and retest to verify systems are running as designed.

■ Retro-Commissioning

- The commissioning of an existing building or facility that was not previously commissioned.

■ Existing Building Commissioning (EBXc)

- Recommissioning and Retro-Commissioning also known as EBCx.

■ Continual Commissioning (MBCx)

- A continuous process ensuring that the operational requirements are maintained over the design life.

Data Collection and Evaluation — ClimaCheck

- **Portable analyzer originally developed in Sweden in 1986**
- **Permanent analyzer developed in 2004**
- **Web-based monitoring launched in 2008**
- **Used by notable global companies in commercial, industrial, institutional and retail facilities**
- **Standard for commissioning and recommissioning of systems throughout the world**



The Climate Solver objective is to strengthen the development and increase the use of transformative technologies which have a great potential to reduce carbon dioxide emissions and increase energy access around the globe.

Data Collection and Evaluation

- **Thermodynamic evaluation = unbiased system view**
 - No information about external loads, compressors, etc.
 - Electrical sub-metering, temperatures and pressures

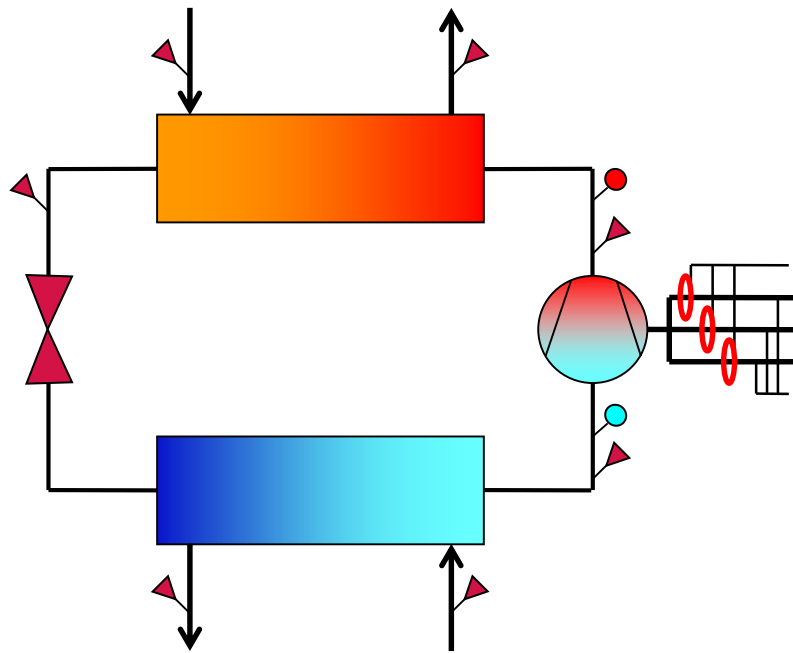

- 2 pressure sensors
- 7 temperature sensors
- 1 power meter

Project Specifics – What Did We Do?

- **Picked a test site**
 - Southern Ontario
 - 42,000 ft²
 - Built in 1991
- **Contacted Local Distribution Company (LDC)**
 - saveONenergy incentives
- **Baseline existing MT and LT refrigeration systems**
- **Developed series of demonstration projects**
 - Project #1: Recommissioning (Existing Building Commissioning) — EBCx
 - Project #2: Adiabatic cooling (condenser misting)
 - Project #3: Variable capacity compressors (Digital Discus™)

Data Collection: System-Specific Flow Chart

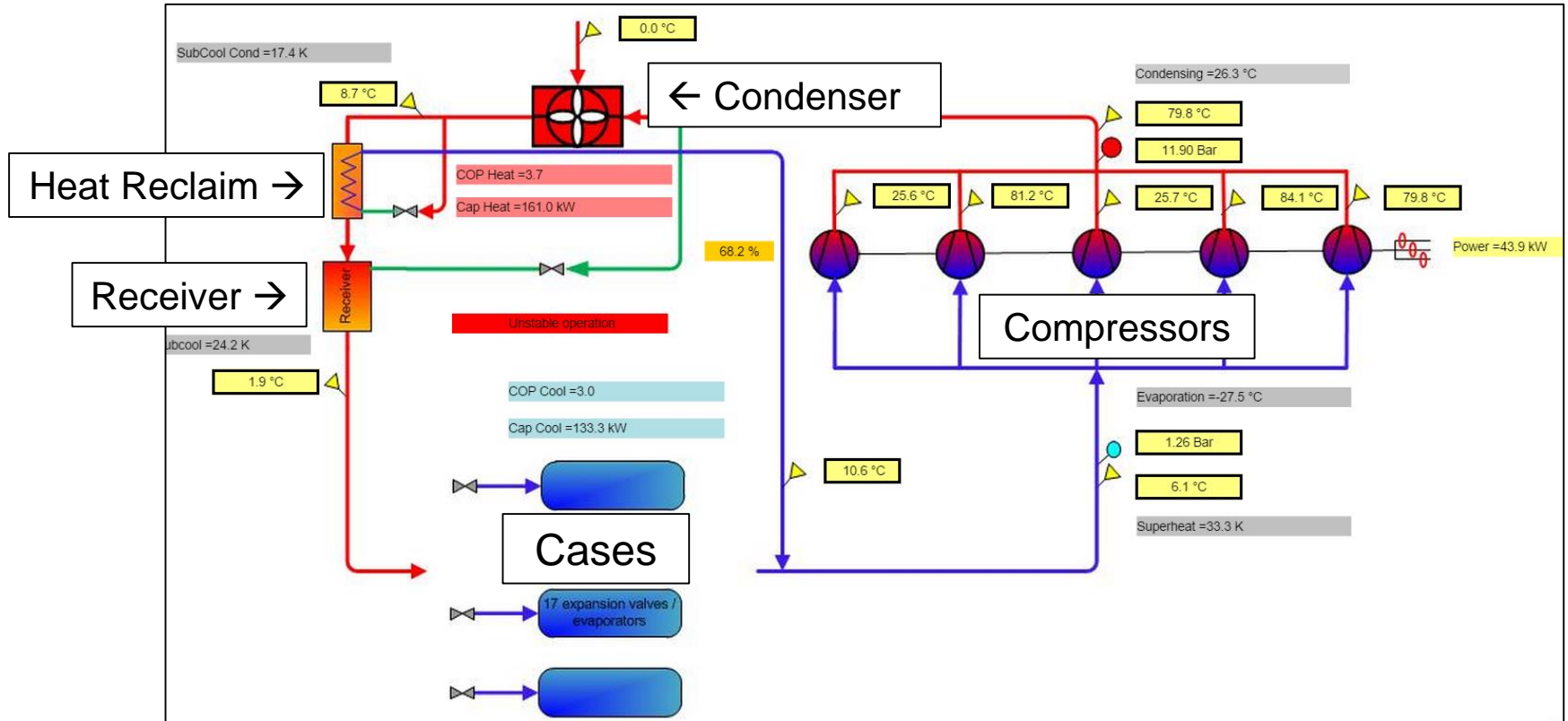

Baseline Existing System

- **Performance monitoring and analyzing system**

- Real-time data logging

- Electrical sub-metering, temperatures and pressures at one-minute intervals

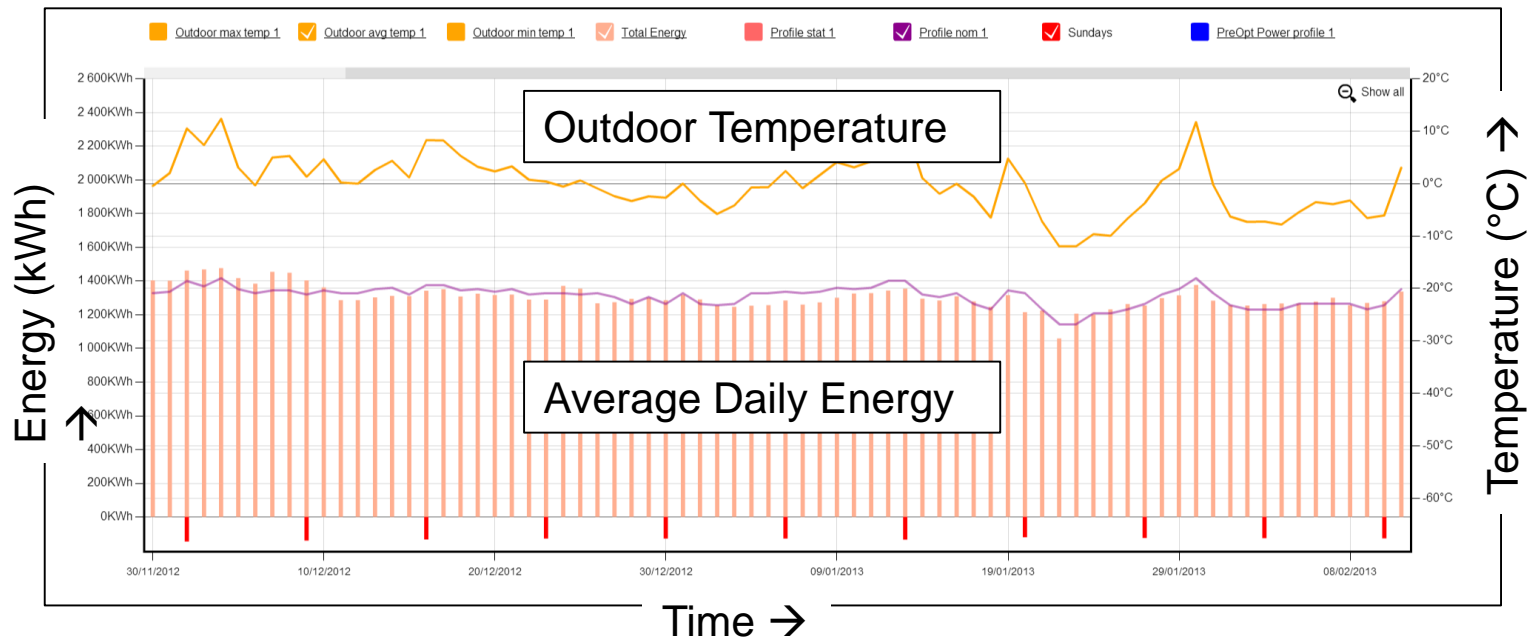

Power Profile — Measurement and Verification

■ Power Profile (Weather Normalized)

- Average kWh at each Outdoor Ambient Temperature (OAT)
 - Averaged over one hour
 - Averaged by additional data points

■ Measurement and Verification (M&V)

- Pre- and post-project power profile (kW/°C)
- Bin temperature data (°C hours)
- kWh/year savings

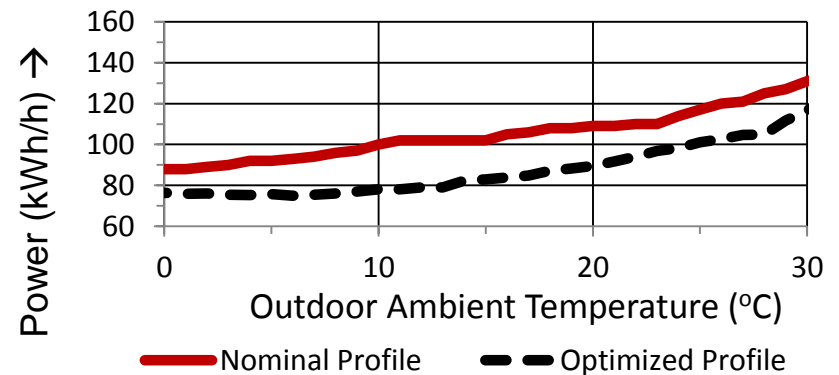

System Efficiency Index (SEI)

- **Normalized unit of absolute efficiency**
- **Introduced by VDMA (Germany) and IOR (UK)**
- **Independent of operating conditions**
 - Coefficient of Performance (COP), Energy Efficiency Ratio (EER), etc. based on design/standard conditions
 - Saturated suction temperature and condensing temperature
 - SEI is the ratio between Carnot COP and actual COP
 - Ratio should not change over varying ambient conditions
- **Evaluation of sub-system performance**
 - Compressor (isentropic efficiency)
 - Evaporator
 - Condenser
 - Auxiliary loads

System Efficiency Index (SEI)

- **SEI independent of outdoor ambient temperature**

- Should be consistent across wide range of temperatures
- Changes vs. temperature represent issues with sub-system performance
- Differences between systems represent overall efficiency differences

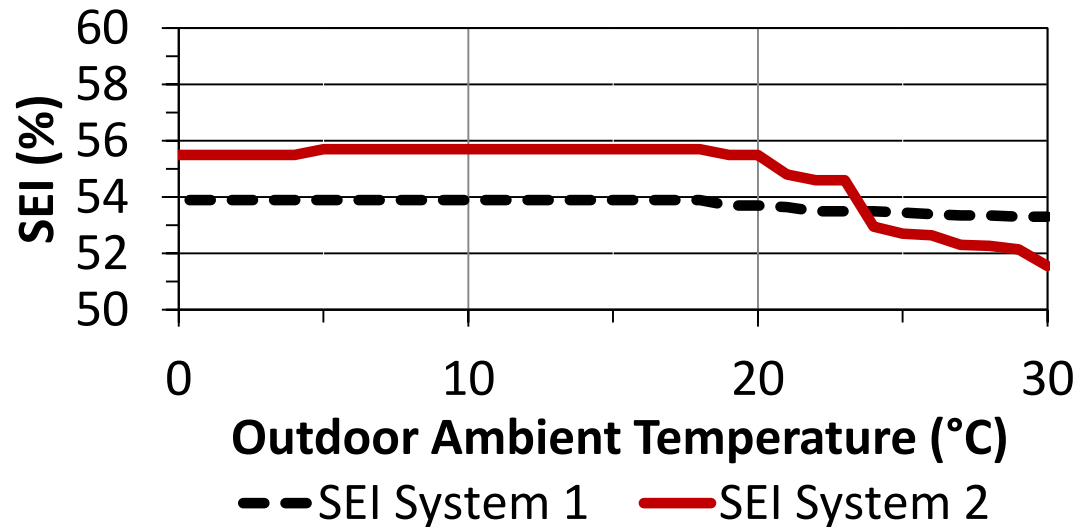

Project #1: Recommissioning

- **Low- / No-cost optimization**
- **Opportunities based on reviewing baseline data**
 - Setpoints
 - Sequencing
 - Condenser fan control

Project #1: Before and After

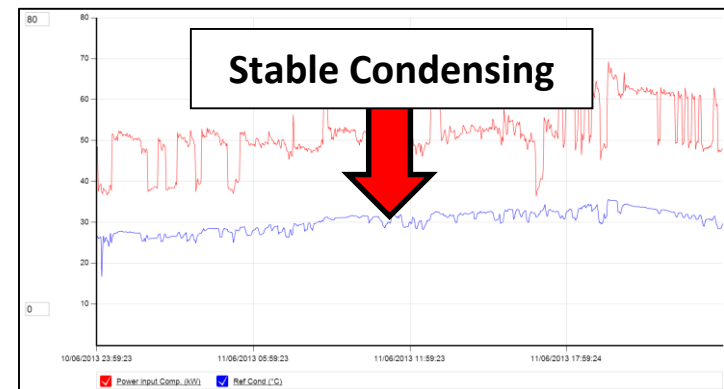
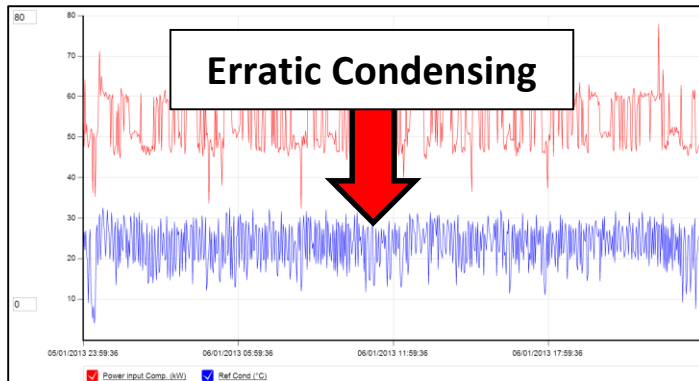
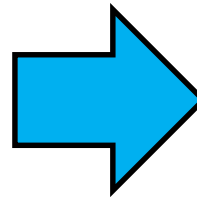
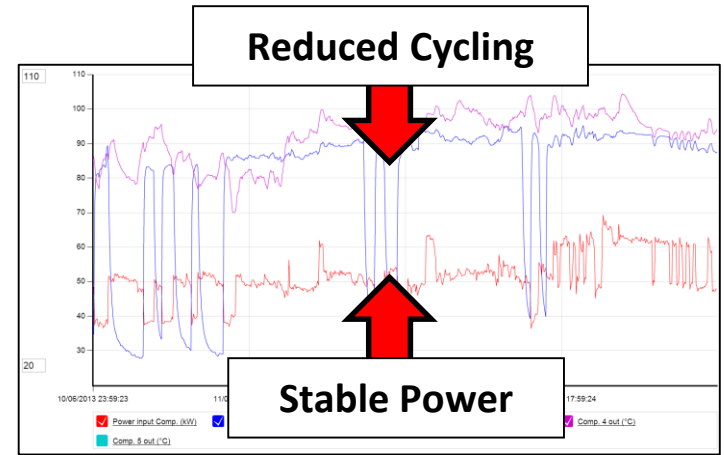
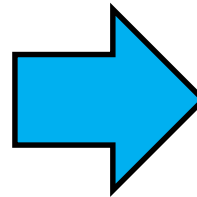
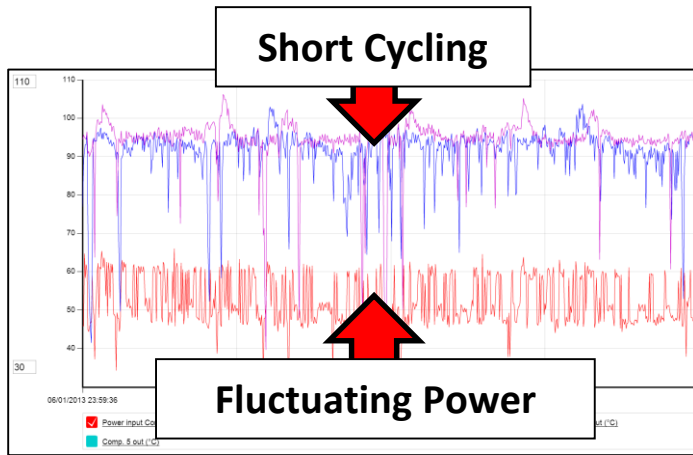

Project #1: M&V — Extended Energy Data

- **Existing Building Commissioning completed March 2013**
 - Annual savings: 173,000 kWh/year
 - Simple payback (after incentives): 1.2 years

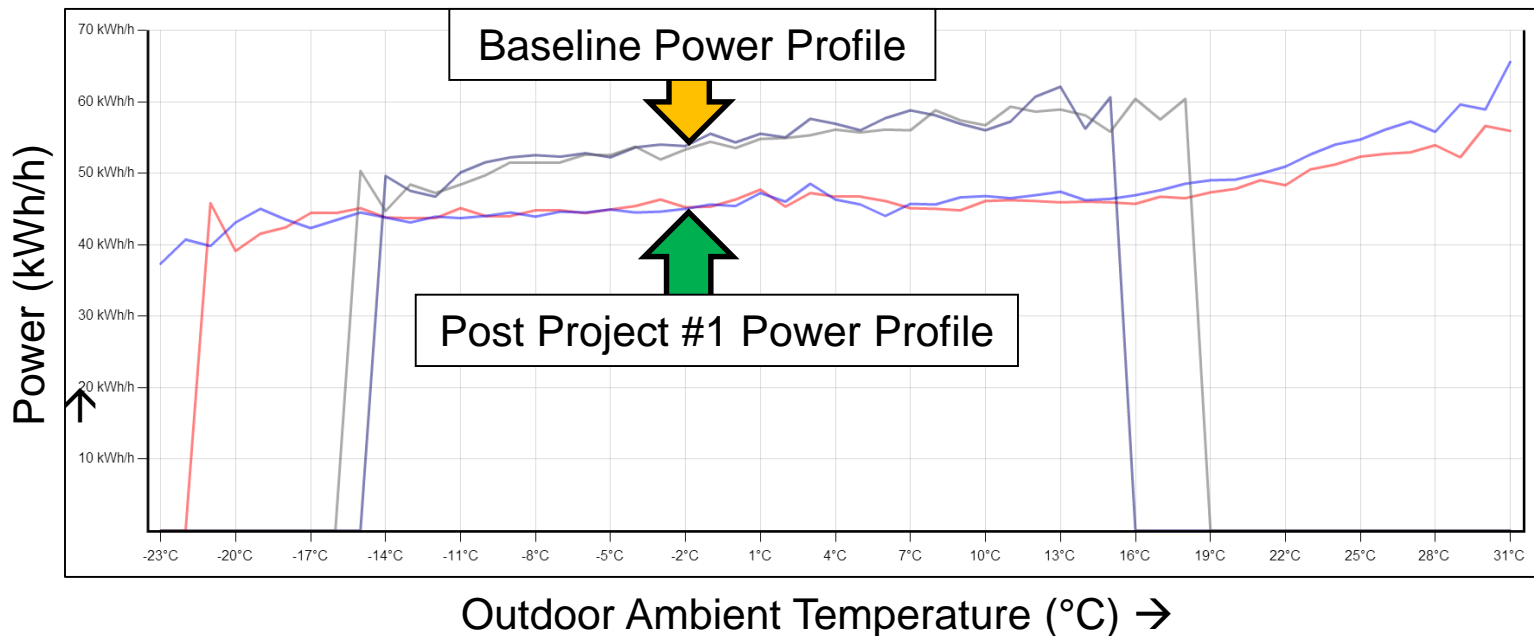

Project #2: Adiabatic Cooling Retrofit

- **Many new air cooled condensers are marginally sized**
- **20-year old condenser often ~20% degraded from new**
- **Garden sprinkler used to wet condenser on hot days**
 - Evaporative cooling: dry bulb versus wet bulb temperature
- **Key issues**
 - Uneven condensing due to uneven wet/dry area
 - Excessive water usage
- **Solution**
 - Install “misting” system
 - Even condensing
 - Significant reduction in water usage

Project # 2: Existing Sprinkler



Project #2: New Misting System

- Nozzles installed under the condenser
- Water is forced into a fine mist and quickly evaporates
- Air temperature drops from dry bulb to wet bulb



Project #2: Utility Savings

- **Sprinklers operate from June to September**
- **Electricity and water / sewage charge savings**
- **2,500 m³ = Olympic swimming pool of water**

Table 2: Pre and Post Implementation Values

Utility	Pre-Implementation† Previous 3 year average	Post-Implementation† 2 year average	Savings	Annual Savings (\$)
Water (Annual Data)	5,618 m ³	2,879 m ³	2,739 m³	\$5,800.00
Electricity (Weekly Data)	17,684 kWh	15,997 kWh	1,687kWh/week 25,305kWh/year	\$2,500.00

Project # 2: Water Savings

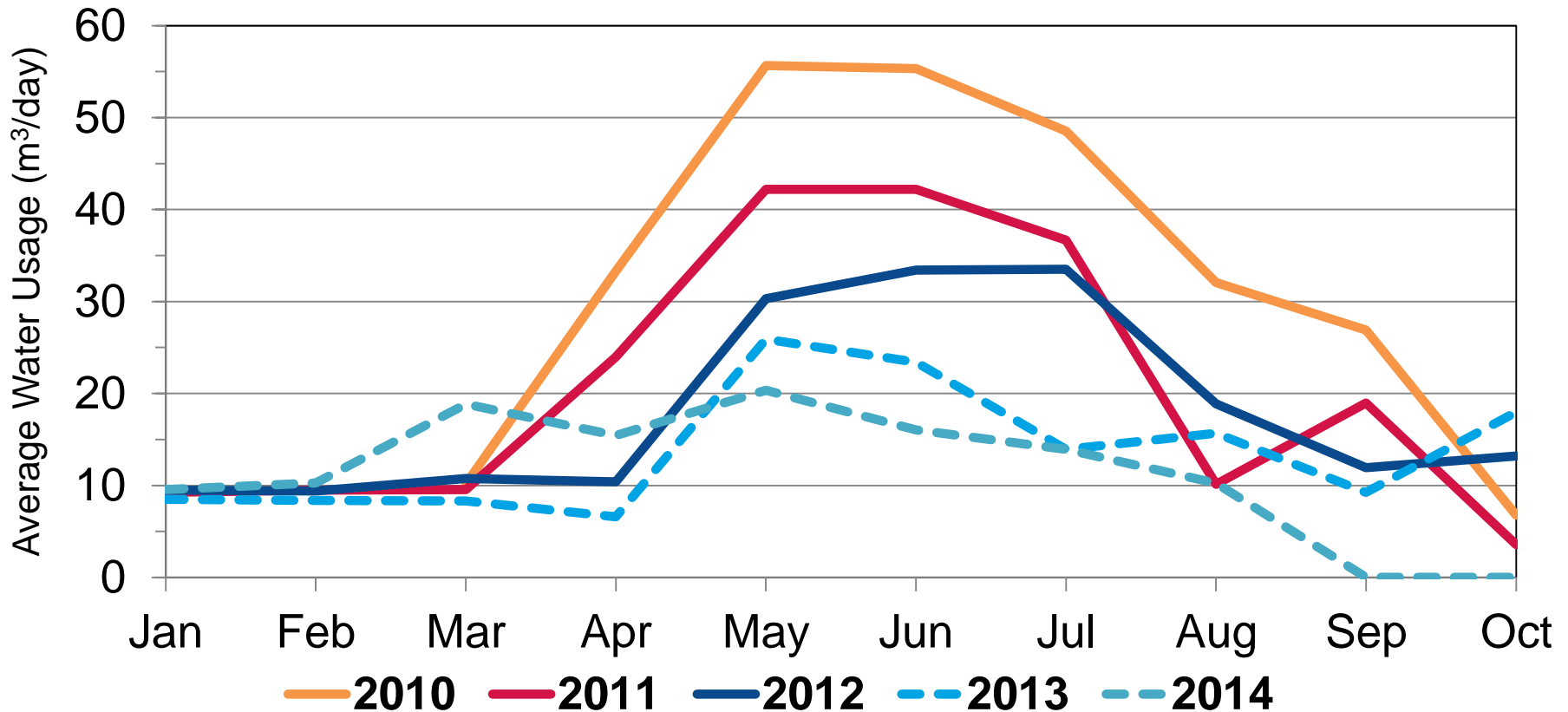

Project #3: Variable Capacity Compressor

- **Upgrade to variable capacity compressor**
 - Both existing refrigeration racks had one weak compressor
 - Opportunity to upgrade from constant capacity to variable capacity compressor
 - Variable capacity compressors allow for better load control

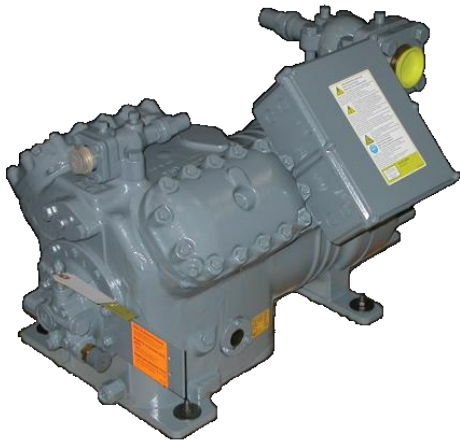

Energy-Efficient
Replacement



Project #3: Variable Capacity Compressor

■ Selection of compressor for upgrade

- High-discharge temperature on compressor indicates failing compressor
- Avoidance of emergency “break-fit” allows time for proper equipment selection and incentive application

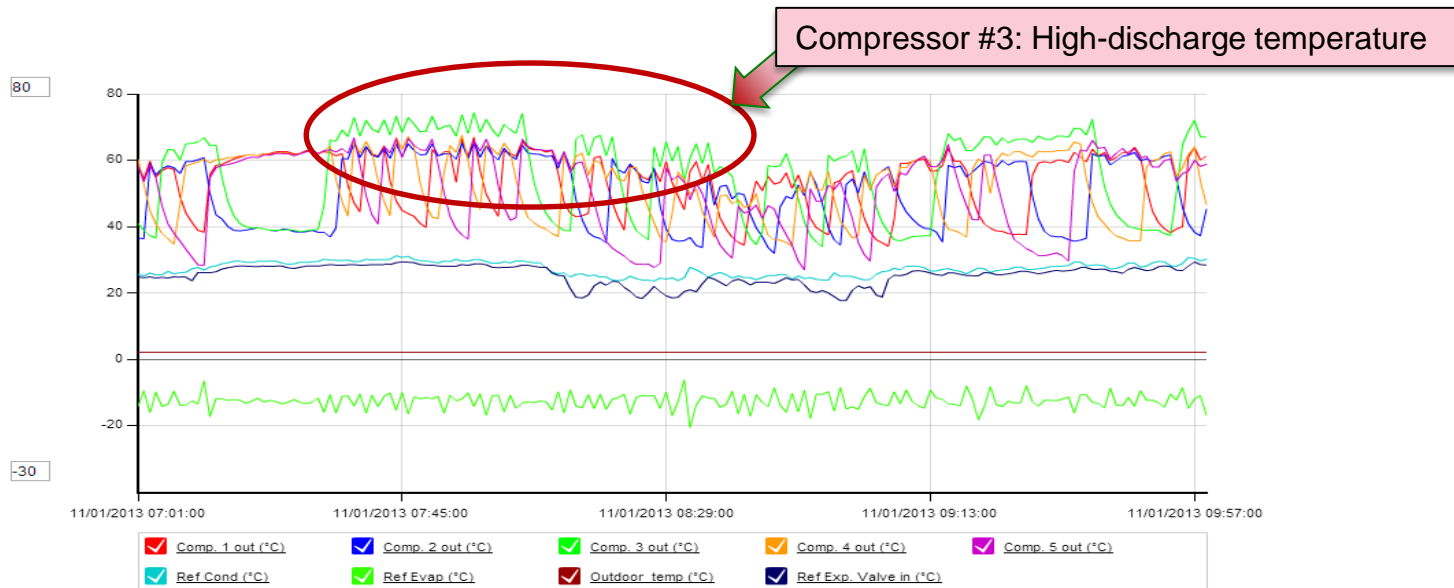

Project #3: Pre- and Post-Energy Data

Table 5: Pre-Implementation Period

System	Pre-Implementation Period Energy Consumption*	Pre-Implementation Yearly kWh Consumption Estimate	Pre-Implementation Peak kW Demand
LT Rack	263,330	433,441	64.5
MT Rack	181,330	343,274	62.6
Total	444,660	776,715	

*Pre-Optimization Period is September 1st 2013 to April 22nd 2014 (223 days)

Table 6: Post-Implementation Period

System	Post-Implementation Period Energy Consumption*	Post-Implementation Yearly kWh Consumption Estimate	Post-Implementation Peak kW Demand
LT Rack	74,988	386,051	62.6
MT Rack	55,344	267,699	59.6
Total	130,332	653,750	

*Post Optimization Period is April 23rd 2014 to June 30th 2014 (69 days)

Annual savings of ~122,000 kWh = \$12,000 @ \$0.10/kWh (~16% energy saving)

Project #3: Business Case

TABLE 14: SUMMARY OF SIMPLE PROJECT COSTS, OPA INCENTIVES, ANNUAL OPERATIONAL SAVINGS AND SIMPLE PAYBACK CALCULATIONS

Total Project Cost	\$ 14,100
OPA Incentives (Max 50% of costs)	\$ 7,050
Net Project Cost	\$ 7,050
Estimated Annual savings	\$ 12,740
Simple payback with Incentives	0.6 years
Simple payback without Incentives	1.1 years

Power Profile: LT M&V (Projects #1, 2 and 3)

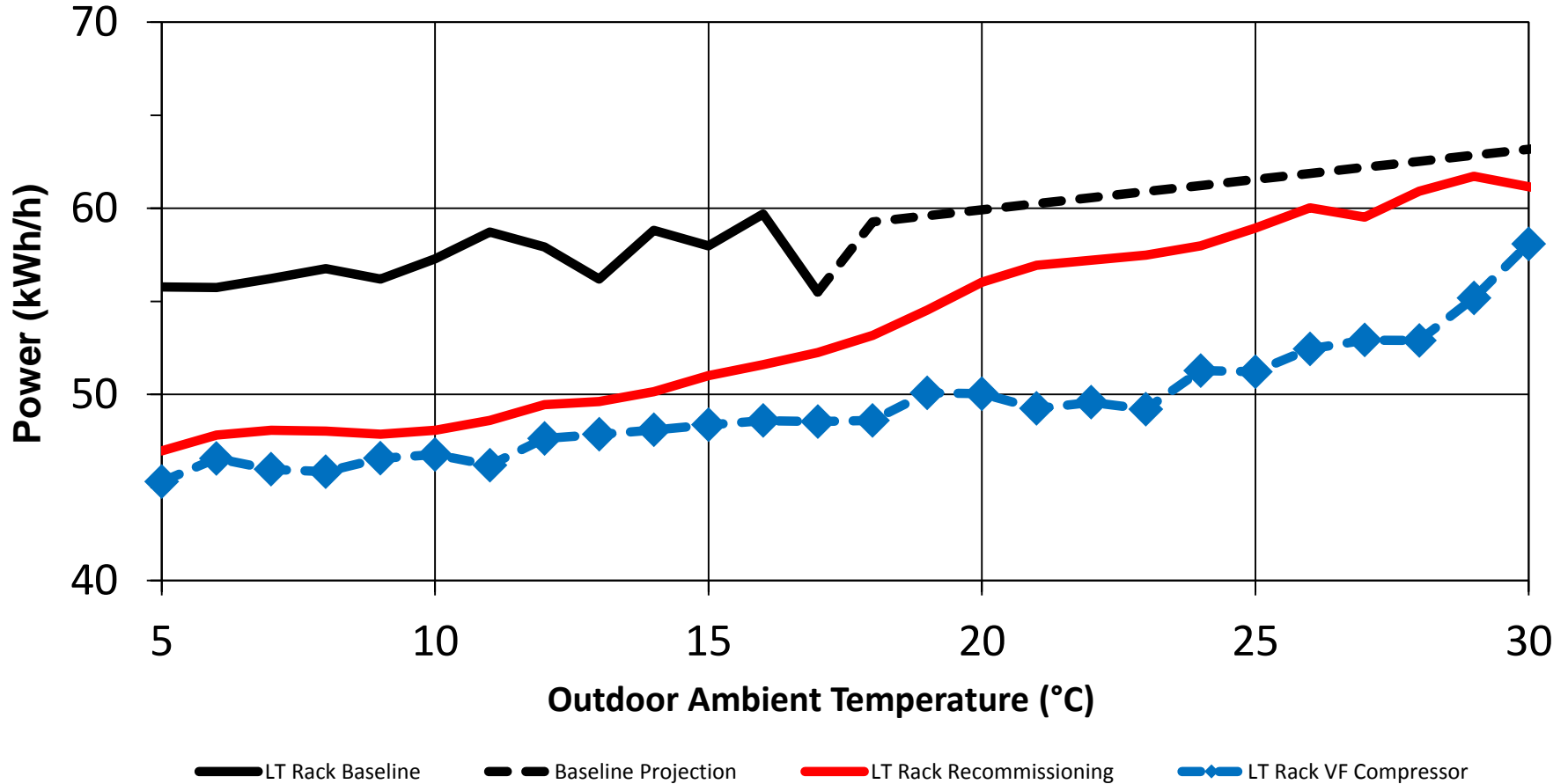

SEI: LT M&V (Projects #1, 2 and 3)

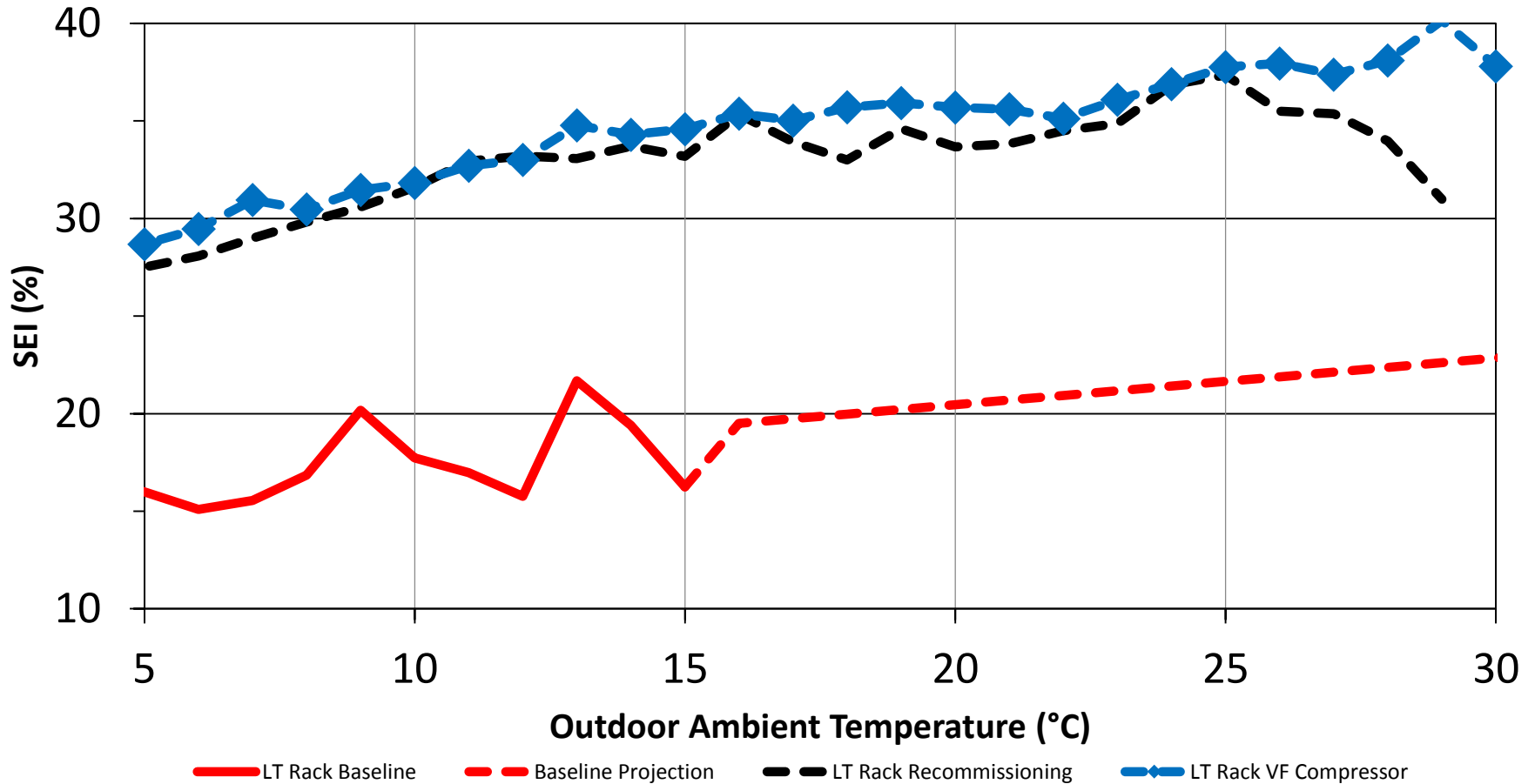

Power Profile: MT M&V (Projects #1, 2 and 3)

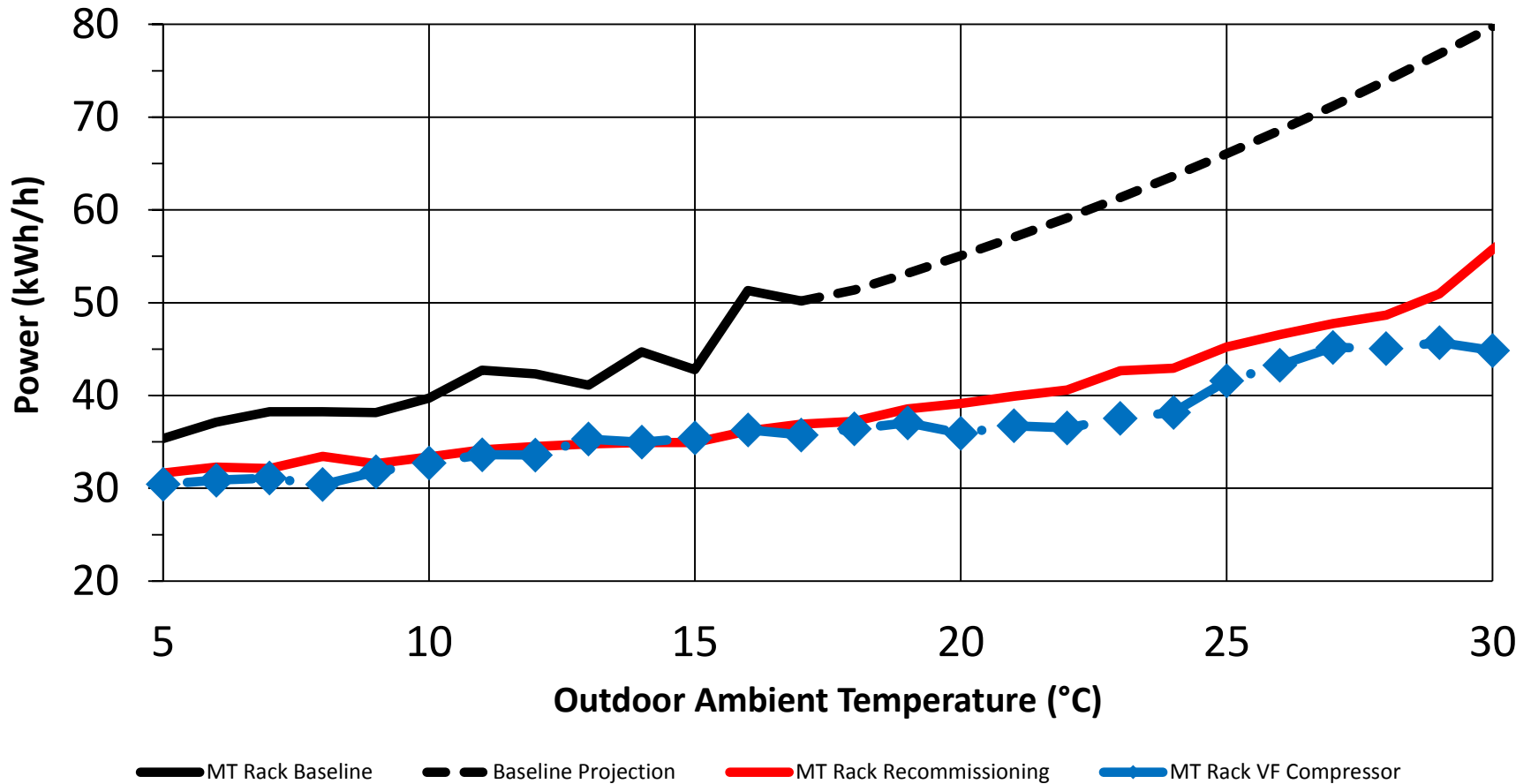

SEI: MT M&V (Projects #1, 2 and 3)

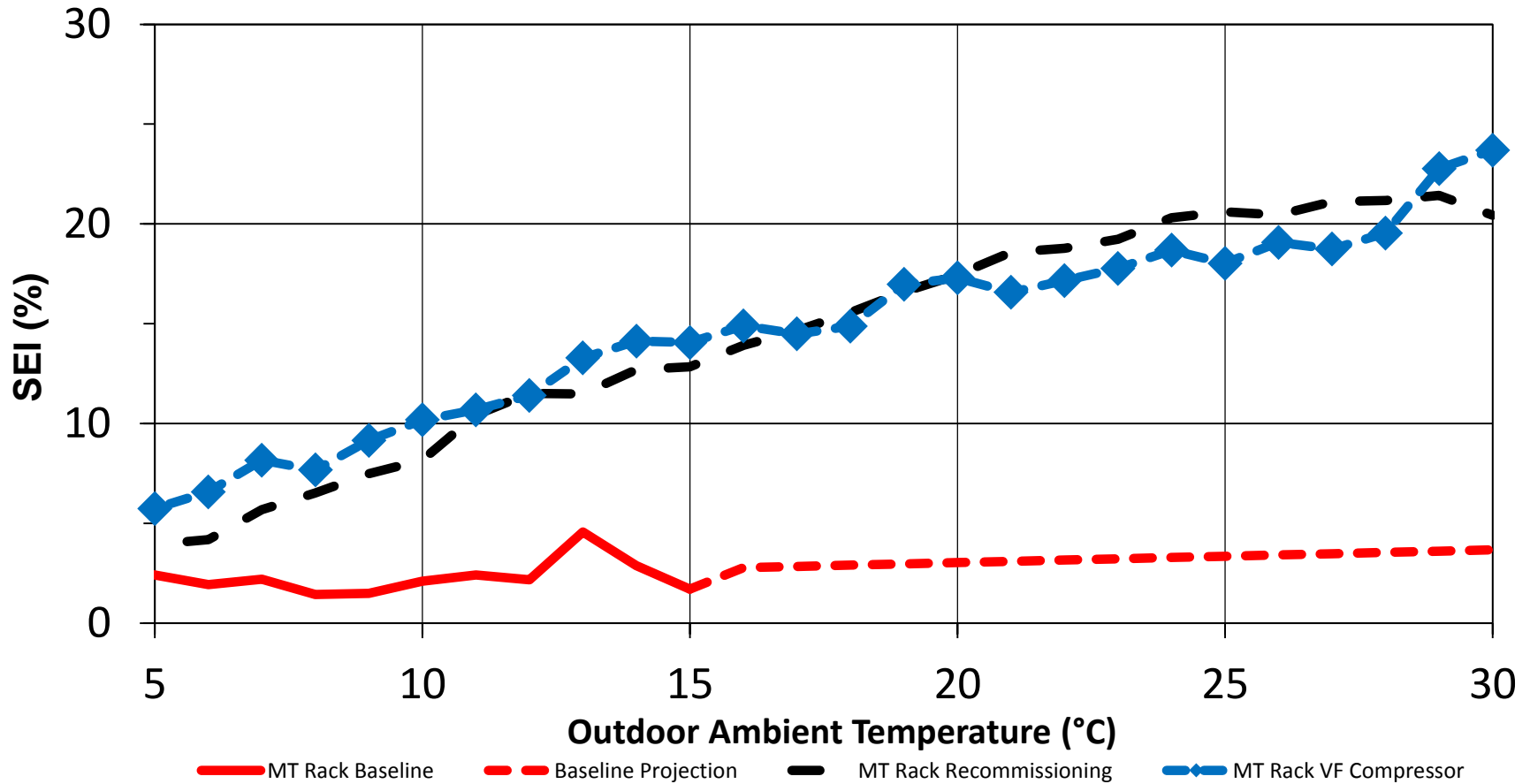

Sustained Savings

- **No degradation in energy use over 30 months**
 - System issues identified through monitoring energy change are corrected:
 - Helps prevent catastrophic shut-down
 - Reduces store-based alarms (down ~66%)
 - Sustains cost savings

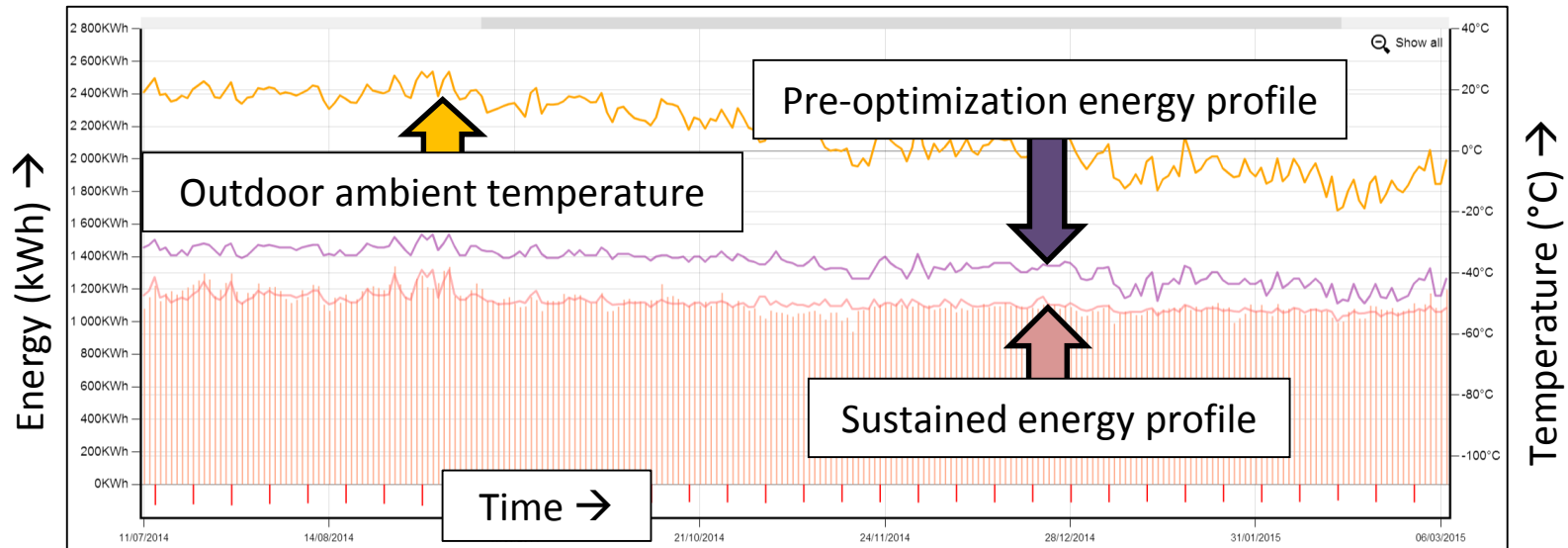

Future Project Opportunities

- **Replace entire refrigeration system (CO₂ transcritical)**
- **Enclosing medium-temperature, multi-deck cases**
 - ~\$100/year/linear foot savings
 - New construction: first cost neutral
 - Replacements: <5-year simple payback (>20% ROI)
- **100% LED vs. linear fluorescent lighting**
 - New construction: <4-year simple payback (>25% ROI)
 - Replacement: <6-year simple payback (>15% ROI)
- **Replacing primary Roof Top Unit (RTU) > 15 years old**
 - <4-year simple payback (>25% ROI)

CO₂ Transcritical Booster System

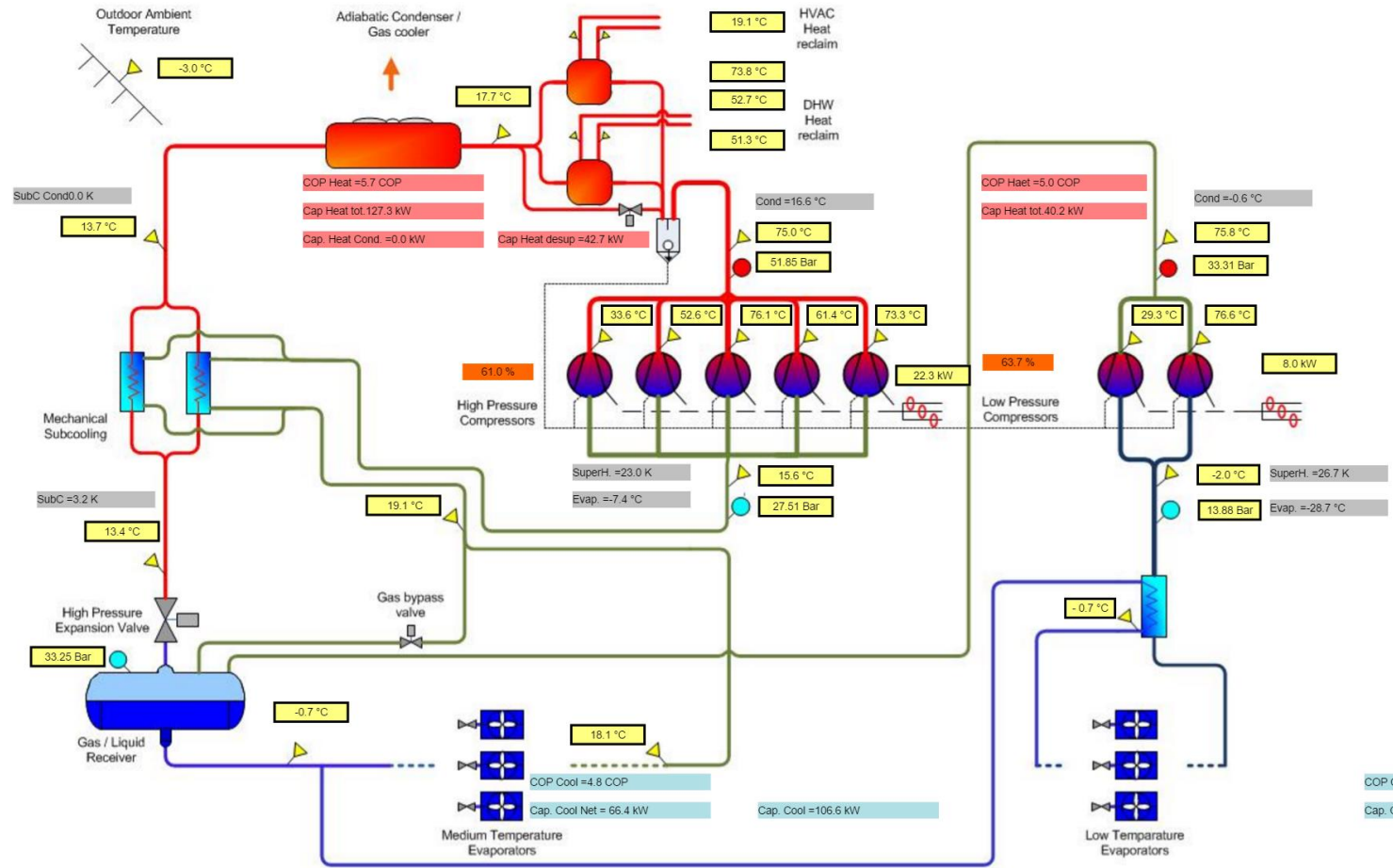

Monitoring-Based Continual Commissioning

- **MBCx**

- Utilizing key performance indicators such as SEI and the Weather Normalized Power Profile can be used to alert to changes in energy consumption and system performance independent of the control system
- Monitor system effectiveness (control system) and efficiency (MBCx)
- The system can be configured to display and monitor as well as compare the sub-system and overall system efficiency utilizing the SEI

- **The owner/energy manager can then quickly identify if a system is operating inefficiently and also identify where within the system the inefficiency resides.**

MBCx Using SEI

Effective doesn't mean EFFICIENT!

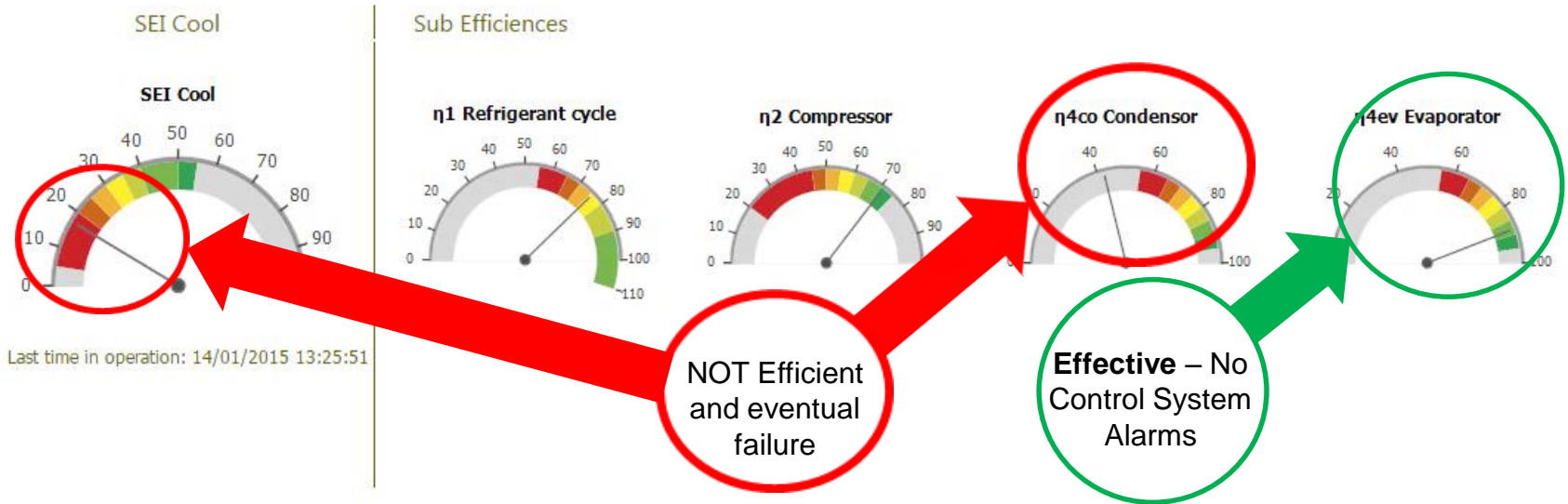

MBCx Using Power Profile

- **Using weather normalized Power Profile**

- By tracking the weather conditions that occur each hour and the Power Profile (average kWh/h), you can predict the energy consumption of the system
- For a system performing well, the actual and predicted energy consumptions should be very similar

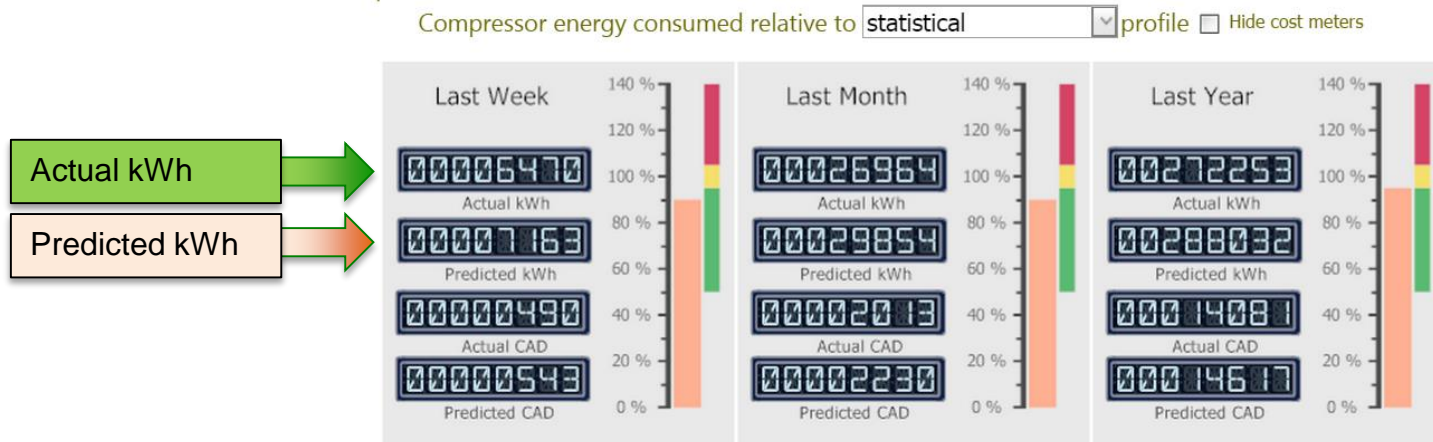

MBCx Using Power Profile Example

- Weekly, monthly and yearly performances

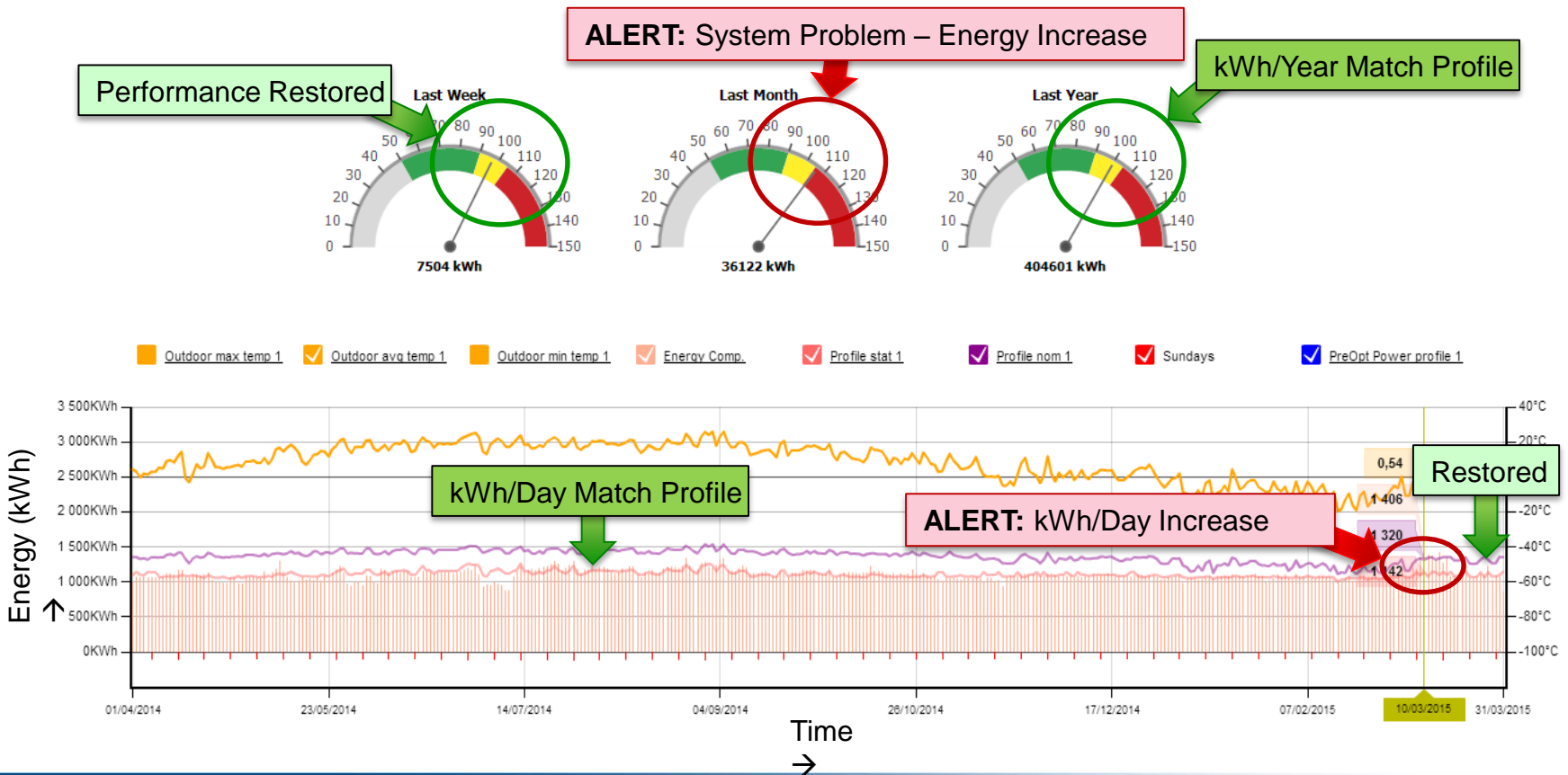

Summary



Energy

- Energy consumption reduced by ~30%
- Electricity rates rising at 10% per year!



Equipment

- Better operating equipment means less down time and potential spoilage
- SEI helps reduce “Break-Fix” expense
- Store-based “nuisance” alarms reduced ~66%



Environment

- Reduced energy consumption reduces CO₂ emissions associated with electricity generation



Economics

- Store operational expense reduced by ~ \$35,000/year (at 2% profit, this is the same as increasing sales by \$1,750,000!)
- Incentives contributed to ~40% of total project cost

Thank You!

Questions?

DISCLAIMER

Although all statements and information contained herein are believed to be accurate and reliable, they are presented without guarantee or warranty of any kind, expressed or implied. Information provided herein does not relieve the user from the responsibility of carrying out its own tests and experiments, and the user assumes all risks and liability for use of the information and results obtained. Statements or suggestions concerning the use of materials and processes are made without representation or warranty that any such use is free of patent infringement and are not recommendations to infringe on any patents. The user should not assume that all toxicity data and safety measures are indicated herein or that other measures may not be required.